

1

Kit 145179

CHEVROLET Colorado, 4-dr Crew Cab, 15-22

GMC Canyon, 4-dr Crew Cab, 15-22

HOLDEN Colorado, 4-dr Crew Cab, 12-20

ISUZU D-Max, 4-dr Crew Cab, 12-20

ISO 11154-E

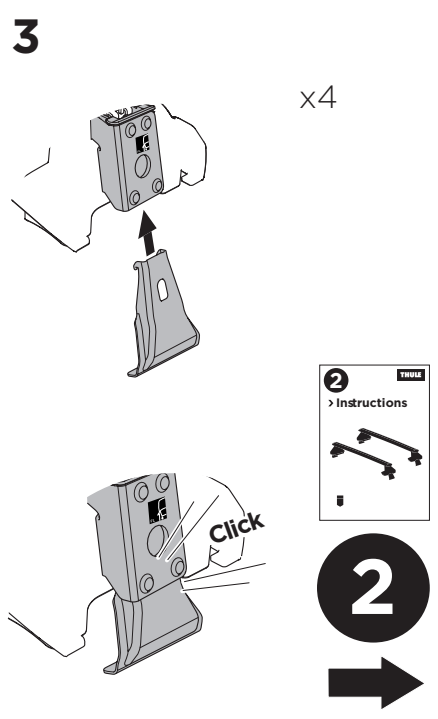
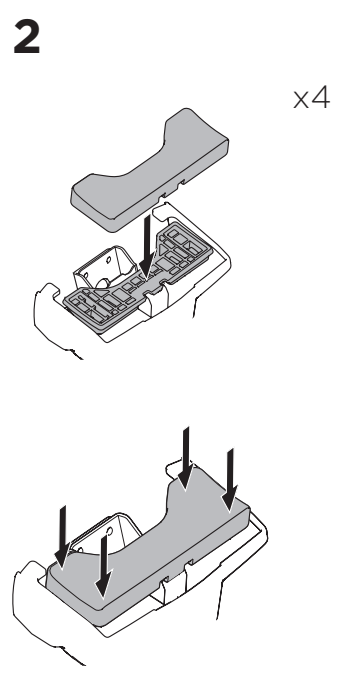
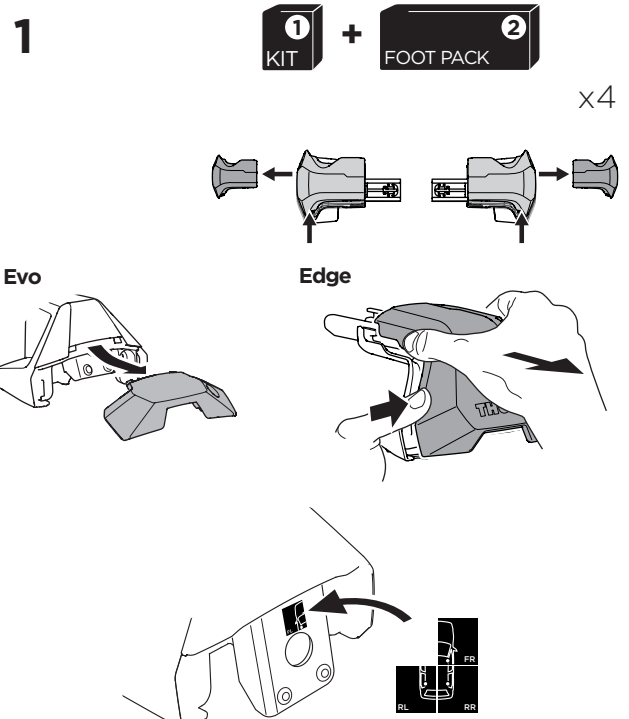
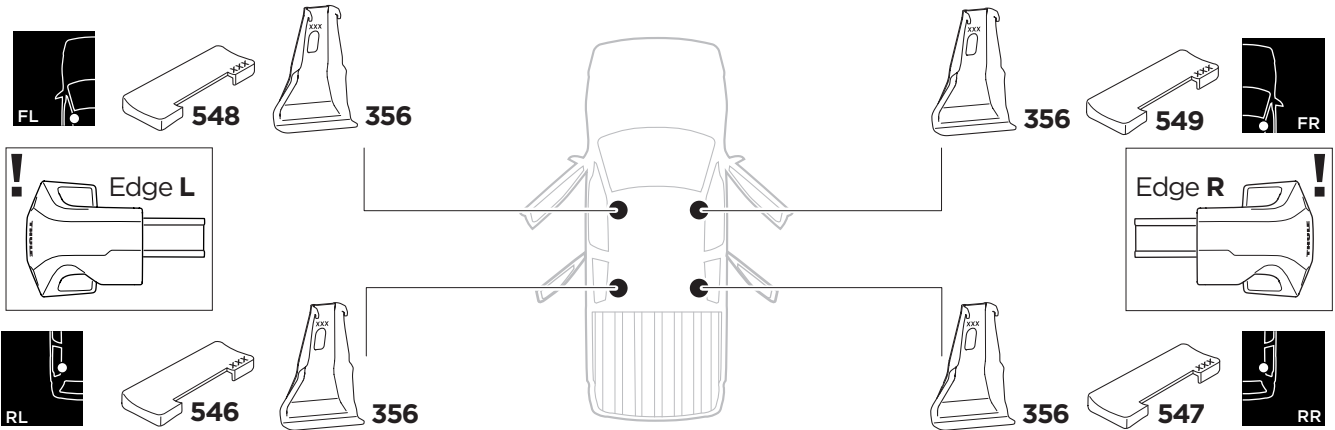
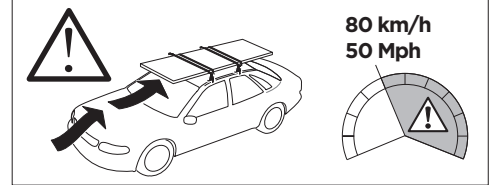
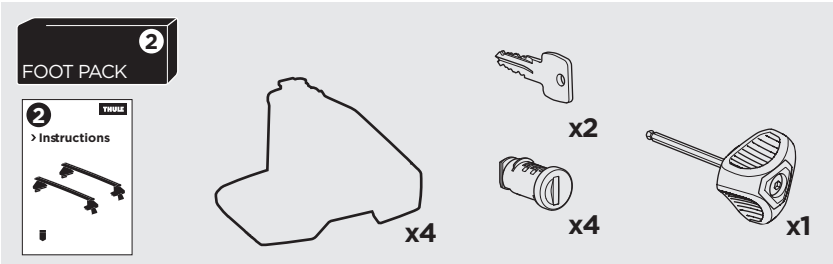
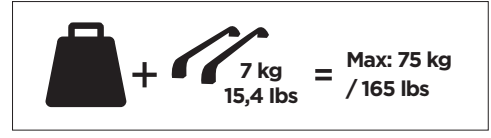
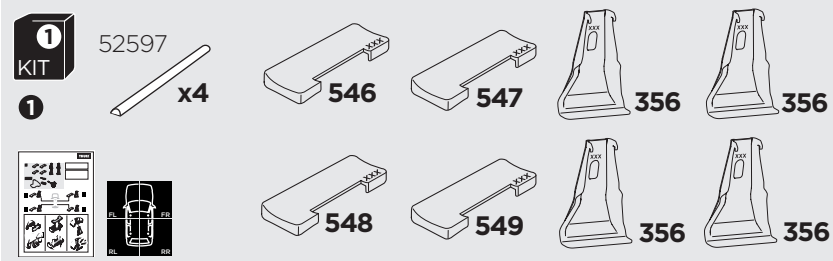

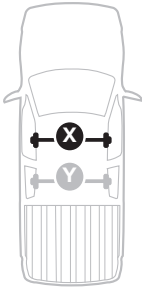

THULE WingBar Evo THULE WingBar Edge THULE WingBar THULE SquareBar Evo	Evo X (scale)	Edge X (scale)
CHEVROLET Colorado , 4-dr Crew Cab, 15-22	42	M
GMC Canyon , 4-dr Crew Cab, 15-22	42	M
HOLDEN Colorado , 4-dr Crew Cab, 12-20	42	M
ISUZU D-Max , 4-dr Crew Cab, 12-20	42	M

THULE ProBar Evo THULE SlideBar Evo	X (mm/inch)
CHEVROLET Colorado , 4-dr Crew Cab, 15-22	1071 mm / 42 1/8"
GMC Canyon , 4-dr Crew Cab, 15-22	1071 mm / 42 1/8"
HOLDEN Colorado , 4-dr Crew Cab, 12-20	1071 mm / 42 1/8"
ISUZU D-Max , 4-dr Crew Cab, 12-20	1071 mm / 42 1/8"

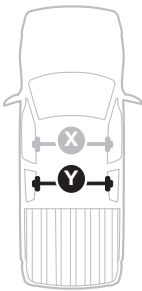

THULE WingBar Evo THULE WingBar Edge THULE WingBar THULE SquareBar Evo	Evo Y (scale)	Edge Y (scale)
CHEVROLET Colorado , 4-dr Crew Cab, 15-22	41,5	N
GMC Canyon , 4-dr Crew Cab, 15-22	41,5	N
HOLDEN Colorado , 4-dr Crew Cab, 12-20	41,5	N
ISUZU D-Max , 4-dr Crew Cab, 12-20	41,5	N

THULE ProBar Evo THULE SlideBar Evo	Y (mm/inch)
CHEVROLET Colorado , 4-dr Crew Cab, 15-22	1066 mm / 42"
GMC Canyon , 4-dr Crew Cab, 15-22	1066 mm / 42"
HOLDEN Colorado , 4-dr Crew Cab, 12-20	1066 mm / 42"
ISUZU D-Max , 4-dr Crew Cab, 12-20	1066 mm / 42"

	W (mm/inch)	Z (mm/inch)
CHEVROLET Colorado , 4-dr Crew Cab, 15-22	700 mm / 27 1/2"	300 mm / 11 3/4"
GMC Canyon , 4-dr Crew Cab, 15-22	700 mm / 27 1/2"	300 mm / 11 3/4"
HOLDEN Colorado , 4-dr Crew Cab, 12-20	700 mm / 27 1/2"	300 mm / 11 3/4"
ISUZU D-Max , 4-dr Crew Cab, 12-20	700 mm / 27 1/2"	300 mm / 11 3/4"

