

17W 4013

Mitsubishi L200, Md. 2015

EU-pedestrian protection bar 60 mm with cross pipe 42 mm

EU-Personenschutzbügel 60 mm mit Querrohr 42 mm

Protection avant, homologuée CEE, 60 mm, traverse 42 mm



ASSEMBLY INSTRUCTION

Montageanleitung • Instructions de montage



URL: Manual

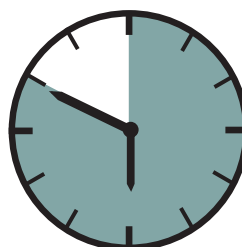

50 Minuten

article no.:
17W4013 (S) inox
17W5013 black steel

Revision 6: 20.11.2018



www.antec-online.de

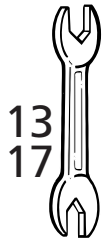

M8 (A2):
21,4 Nm
M8:
25 Nm
M10:
50 Nm

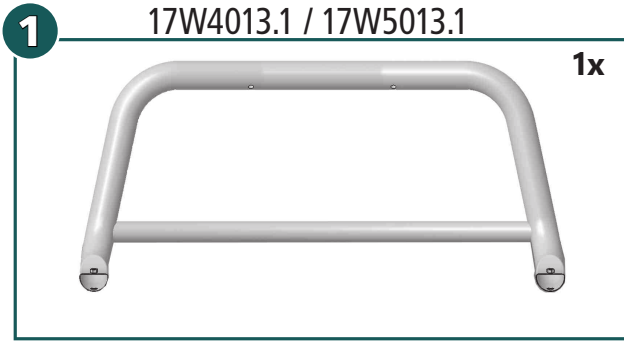
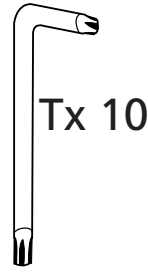
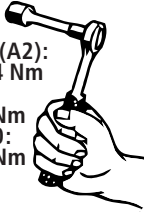

mounting kit: 17W9013

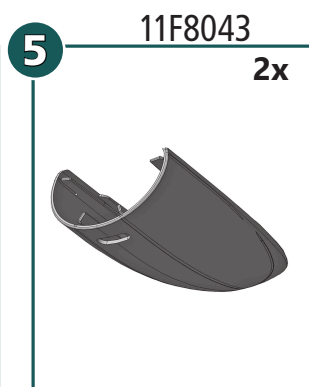
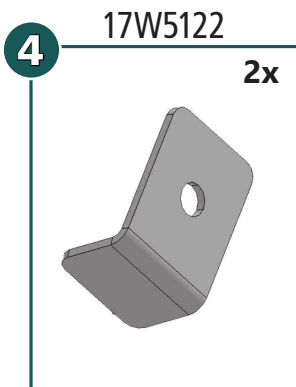
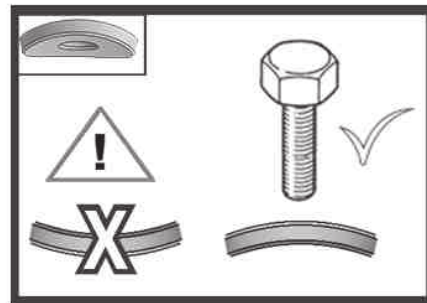
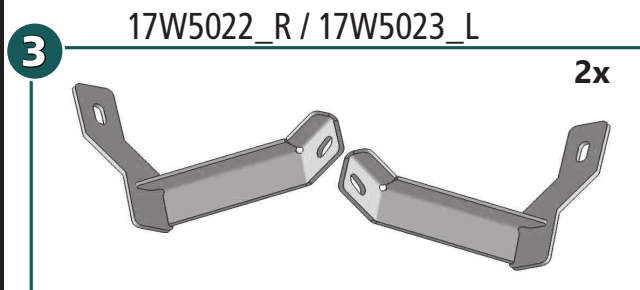
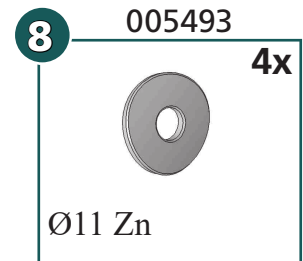
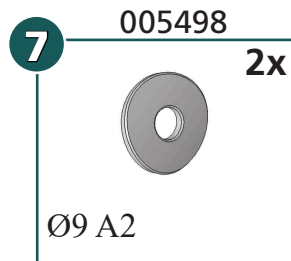
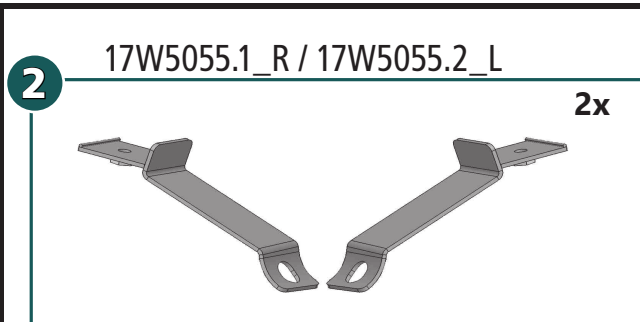
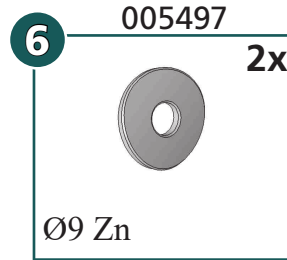







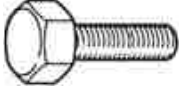
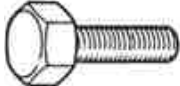

URL EU-approval

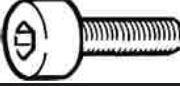
article no.:
17W4013 (S) inox
17W5013 black steel

Revision 6: 20.11.2018



	M8x25; DIN 933 Zn	2x
	M8x30; DIN 933 A2	2x
	M10x90 (85); DIN 933 Zn	2x
	M8x25; DIN 912 A2	2x
	Ø3,5 x 13; ähnl. DIN 7981B A2	2x
	M10; DIN 934 Zn	2x
	Ø 4,2; DIN 9021 A2	2x
	Ø 8,4; DIN 9021 A2	2x
	SW 13	2x

